

## Zone valves PN10

On-off control signal  
230 V / 24 V

## STC 25/45 VGZ.../XGZ...

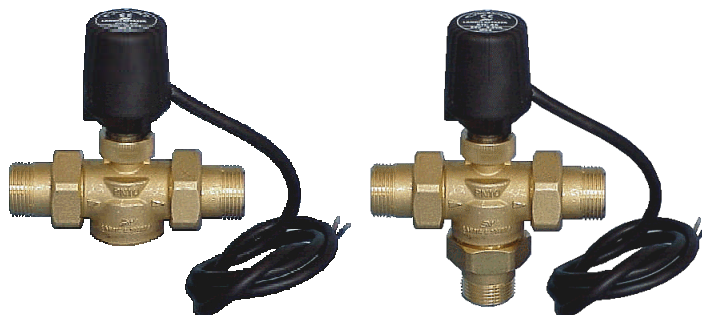

### Zone valves PN 10

- Brass body
- DN 1/2", 3/4", 1"
- VGZ....Two-port valves
- XGZ....Three-port valves
- ON – OFF Thermal actuator

STC 25                    230 V

STC 45                    24 V

### Use

For use in heating and air conditioning systems and the control of hot or cooling water .

### Functions

The 230V (or 24V ) control voltage generates a stroke in the actuator which is transmitted to the valve stem.

When the room temperature decreases the actuator open the valve and when the set-point is reached the actuator close the valve. The auxiliary contact is close or open according to the position of the valve.

#### **Auxiliary contac:**

close        =        valve opened  
open        =        valve closed

### Type summary

#### Valves

DN inches	mm	Two port	kVs m <sup>3</sup> /h	Δp max kPa	Three port	kVs m <sup>3</sup> /h	Δp max kPa
1/2"	15	VGZ 1/2"	2,5	300	XGZ 1/2"	2,5	300
3/4"	20	VGZ 3/4"	4	120	XGZ 3/4"	4	120
1"	25	VGZ 1"	6	100	XGZ 1"	6	100

#### Actuators

Type	Power Supply	Control-signal
STC 25	230 V	ON - OFF
STC 45	24V	ON - OFF

---

**Accessories**

T-piece of third port ( by-pass) for diverting valve, complete of bushes.

T - piece	Mounted bush	Enclosed bushes
TXZ 1/2"	T5	T4,T6
TXZ 3/4"	T6	T5,T7
TXZ 1"	T8	T7,T9

---

**Ordering**

When ordering please give name and type reference of valve, actuator and the accessories where required.

Example: three-port valve with actuator and T-piece :

    XGZ 1/2"

    STC 25

    TXZ 1/2"

Actuator, valve and accessories are packed and delivered separately.

---

**Mechanical design****Valve**

Brass body PN10, stem made from stainless steel and plug made from brass N.B.R. Fittings are included in the packing of valve.

**Actuator**

Actuator with double thermal insulation and stem heating element PTC; housing cover made from plastic. Manual adjusting knob for operating without power supply.

---

**Engineering notes**

- The VGZ.../XGZ...valves are suitable for use only with actuators STC 25 or STC 45
- The three port valves must be always used as a flow control valve for diverting functions
- When mounting, pay attention to the **valve's flow direction symbol** →

---

**Mounting**

Make certain the direction of flow is correct.

The valve is supplied complete with mounting instruction.

Mounting position:



Permissible



Not permissible

The actuator must be mounted on valve without using tools. Check if two clips have been inserted correctly on body valve. Check the actuator function rotating by hand the knob in an anticlockwise ( WITHOUT POWER SUPPLY) till the click.

## Connection

The electric connections must be in accordance with local regulations on electric installations as well as the connecting diagram. The connection cable may not be replaced; having to extend the cable it must be used a shunt box.

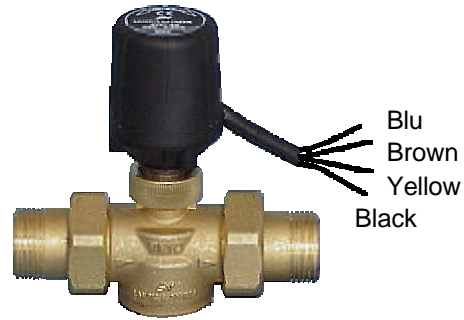
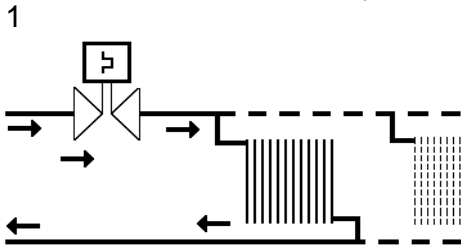

Blu  
Brown  
Yellow  
Black

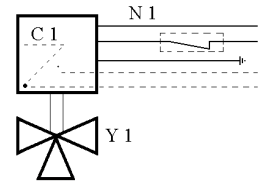
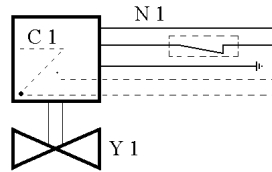
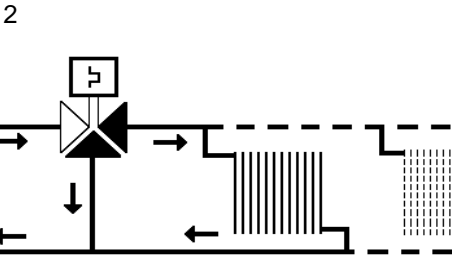

- 1 Two valve  
2 Three port valve

Y1 Zone valve  
N1 Temperature controller  
c1 Auxiliary contact  
L Phase ( Brown )

N Neutral ( Blu )  
Auxiliary contact ( Black )  
Auxiliary contact ( yellow ) } c1

## Technical data

### Valves

Flow characteristic	linear
Working pressure	10 bar
Leakage rate	-----
Temperature of medium	water 5° C...95° C
Stroke	4 mm
Materials:	
Body valve	Brass OT58, UNI575/65
Stem	AISI 303
Stem sealing	VITON
Plug	OT 58, covering N.B.R.
Weight	refer to "Dimensions"

### Thermal actuators

	<b>STC 25</b>	<b>STC 45</b>
Power supply	230V, +10% -15%	24V ± 10%
Frequency	50Hz	50Hz
Power consumption:		
Nominal power	15,5VA	19,2VA
Mean operating power	5,5VA	5VA
Running time:		
Open	3...4 min	3...4 min
Close	5...6 min	5...6 min
Heating element	PTC	
Auxiliary contact	3A/250V (resistive)	
<i>General ambient conditions</i>		
Operation	- 2 ° C...+50 ° C	
Transport and storage	- 10 ° C...+90 ° C	
Humidity	class G, DIN 40040	
Protection	IP 54	
Connection cable	4x1mm <sup>2</sup> , lenght 1m	
CE as per EMC directive	89/336/CEE	
Weight	0.25 Kg	

## Sizing

### Valve diagram

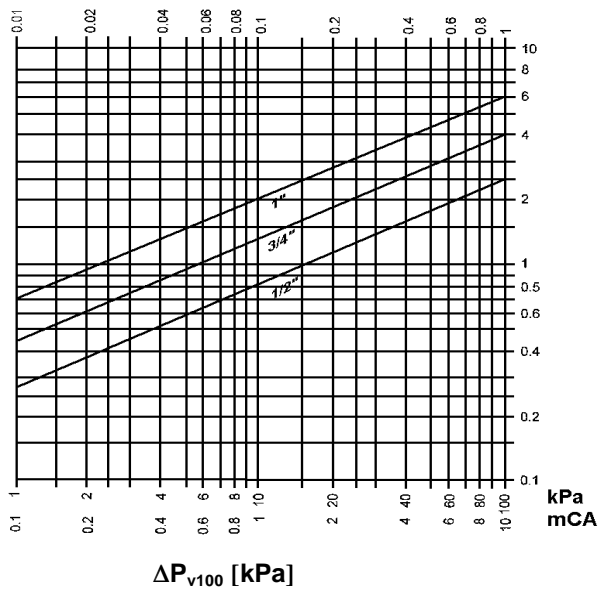

### T setup diagram

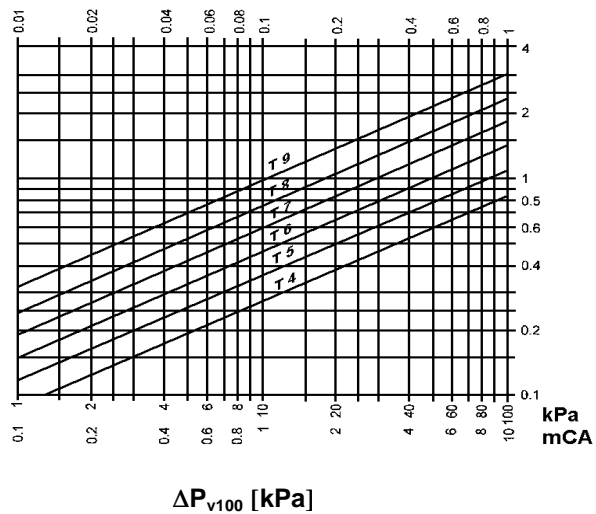

## Dimensions

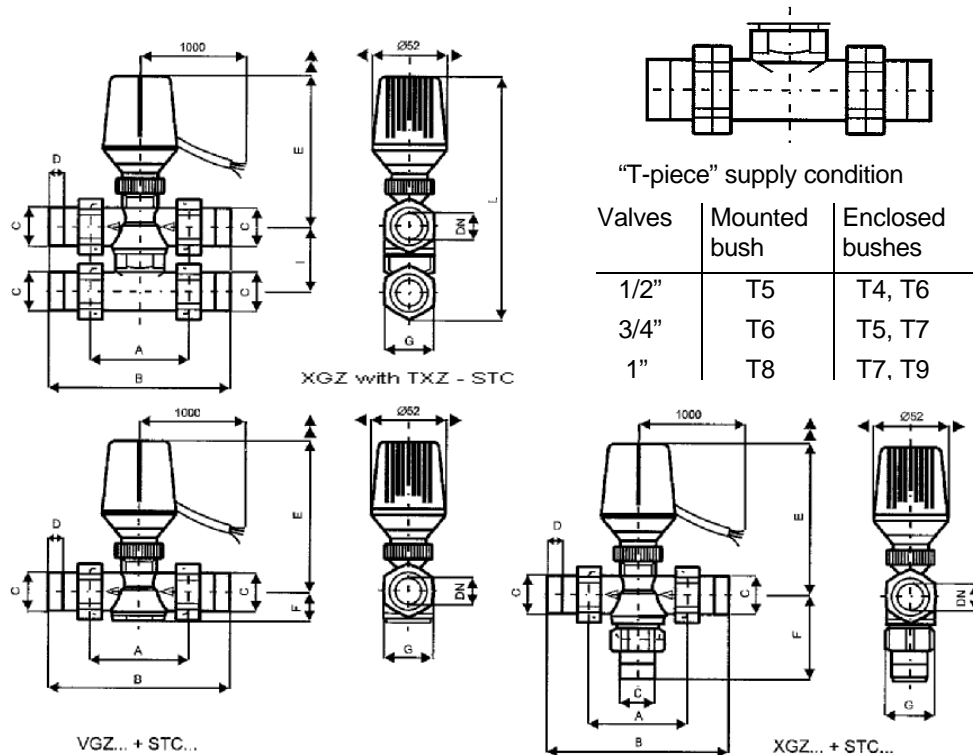

"T-piece" supply condition

Valves	Mounted bush	Enclosed bushes
1/2"	T5	T4, T6
3/4"	T6	T5, T7
1"	T8	T7, T9

Type	A	B	C	D	E	F	G
VGZ 1/2"	63	118	1/2"	10	107,5	21,5	30
VGZ 3/4"	66	127	3/4"	12	107,5	22,5	37
VGZ 1"	70	140	1"	14	108,5	27	47

Type	A	B	C	D	E	F	G	I	L
XGZ 1/2"	63	118	1/2"	10	107,5	52	30	50	174
XGZ 3/4"	66	127	3/4"	12	107,5	61,5	37	50	177,5
XGZ 1"	70	140	1"	14	108,5	71	47	60	214